

EW849 Eyewash, Deck Mounted, AutoFlow™ 90° Swing-Down

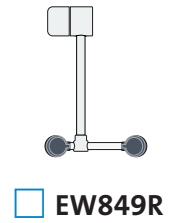

Units shown in plan view

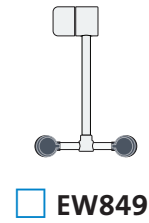
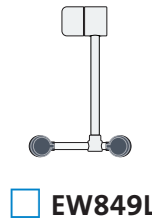
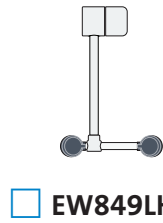
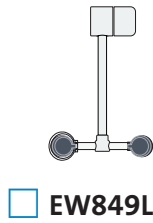
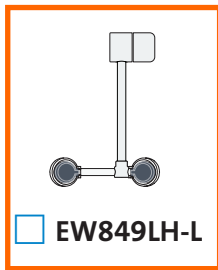

Application: AutoFlow™ eyewash for mounting on counter. Spray heads swing down from storage to operational position, activating water flow. Available in a variety of spray head configurations to minimize obstructions at a sink. *Note: If unit is not installed at a sink, floor drain should be provided underneath unit to prevent accumulation of water on floor.*

Spray Head Assembly: Two GS-Plus™ spray heads. Each head has a “flip top” dust cover, internal flow control and filter to remove impurities from the water flow.

Valve: 1/2" IPS plug-type valve with Teflon® coated O-ring seals. Swinging head assembly down from storage to operational position opens orifice and activates water flow. Unit remains in operation until spray head assembly is returned to storage position.

Strainer: Unit is furnished with in-line strainer to protect valve and spray heads from debris in water line.

Mounting: Valve is installed in Type 316 stainless steel housing. Unit mounts on countertop behind sink. Furnished with mounting hardware for securing unit to counter.

Construction: Polished chrome plated brass.

Supply: 1/2" NPT male inlet.

Sign: ANSI-compliant identification sign.

Quality Assurance: Unit is completely assembled and water tested prior to shipment.

Available Options

- TMV** AP3600 thermostatic mixing valve precisely blends hot and cold water to deliver warm (tepid) water as required by ANSI Z358.1-2014. Refer to “Tempering Units” section for complete technical and product selection information.

EW849 Eyewash, Deck Mounted, AutoFlow™ 90° Swing-Down

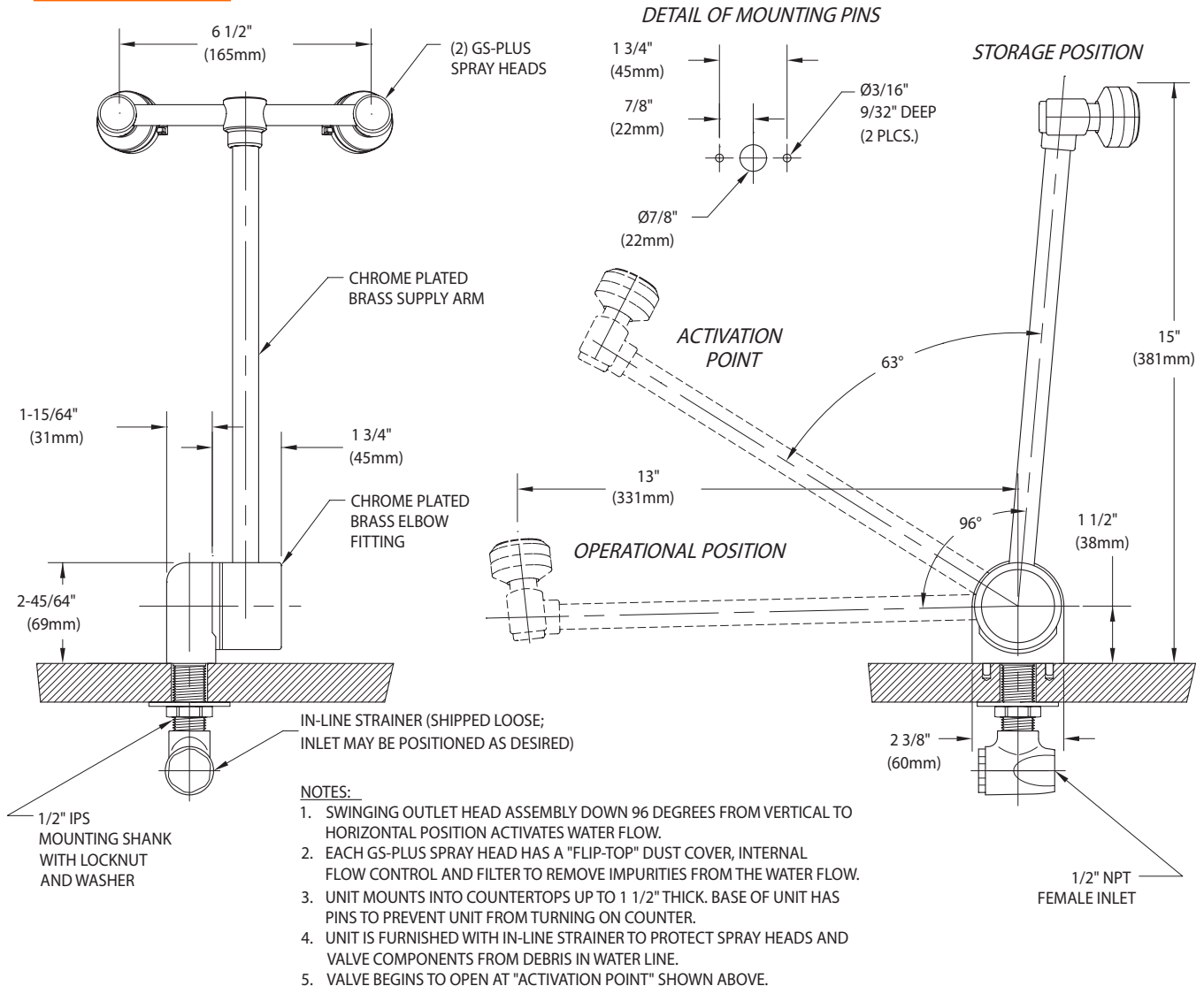
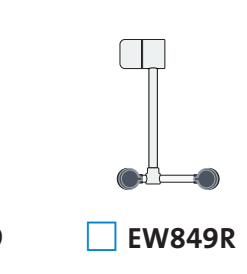
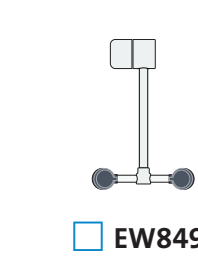
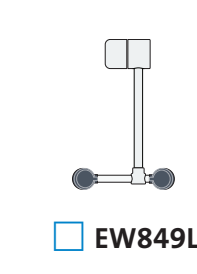
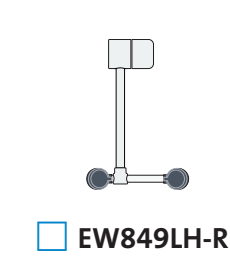
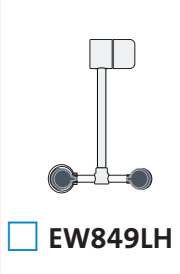
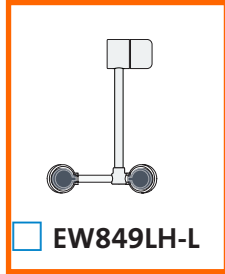

THIS SPACE FOR ARCHITECT/ENGINEER APPROVAL

Due to continuing product improvement, the information contained in this document is subject to change without notice. All dimensions are ± 1/4" (6mm). rev. 0615

Sign Included

